



ENGLISH

Universal thermostat with 11 built-in and selectable functions.
Multi-voltage: 24V AC/DC and 230V AC.



WARNING: IMPORTANT INFORMATION CONCERNING ELECTRICAL SAFETY AND ENVIRONMENT

The product may incorporate lethal voltage. The product's enclosure is not intended to be opened. At 230V AC supply voltage the product shall be powered via a proximally mounted disconnection device marked: "Disconnection device for thermostat CMT". The product's relay switch can be energised with 230V which must be disconnected prior to conducting maintenance work. The product is intended for indoor use. The product shall not be subjected to liquids or moisture. The outside of the product can be cleaned using a slightly moist cloth rag. The product is intended for installation on a DIN rail / Norm enclosure in an area protected from the public.

INDEX

1. Technical data
2. Function
3. Use
4. Installation
5. Maintenance
6. Buttons and menu system
7. Selection of application/function
8. Selection of temperature sensor type - factory setting: Pt1000
9. Setting of preferred/ set point values
10. Setting of hysteresis
11. Fine-adjustment of the temperature measurement
12. Setting of timer function
13. Display example
14. Error codes and temperature/ohm table
15. Resetting factory settings
16. Figures
17. Connection example for each respective application
18. Menu system – overview/quick menu

1. TECHNICAL DATA

Supply voltage: 24V AC $\pm 10\%$,
24V DC $\pm 5\%$ and
230V AC $\pm 10\%$ 50-60 Hz

Relay outputs: 250V ~ 5A resistive loading, change-over potential-free

Power consumption: 4W

Temperature range: -99 to +600°C

Ambient temperature: 0 to +40°C

Selectable temp.sensors: Pt1000 (factory setting), Pt100, Ni1000, NTC (Calectro type: 22/33/44/55/99) and PTC (Calectro type: 95)

Temperature range for different sensor types:

Pt1000: -99 to +600°C
Pt100: -99 to +600°C
NTC: -10 to +125°C
PTC: -25 to +110°C
Ni1000: -30 to +125°C

Switching differential: 0-15°C in stages of 0.2°C

Mounting: DIN rail, Norm-enclosure

Dimensions WxHxD: 52.5 x 86 x 59mm

Weight: 240 g.

Enclosure class: IP20

2. FUNCTION

CMT can be powered by 24V AC/DC via plinth 15-16 or 230V AC via plinth 1-2. See figure 2. CMT has two alternating potential-free relay outputs (5 A, 250V) and has an adjustable hysteresis (switching differential) which is centred over the reference value.

CMT carries out a self-test during start-up and following change of temperature sensor. Three bars blink at the lower part of the display. Once the self-test has finished the actual temperature will be displayed. In the case of interruption to the temperature sensor the display shows Er0 and in the case of short-circuit Er1 is displayed.

3. USE

Universal thermostat with 11 built-in and selectable functions:

- | | |
|----------|---|
| Appl. 1 | 1-stage heating thermostat |
| Appl. 2 | 1-stage cooling thermostat |
| Appl. 3 | 2-stage heating thermostat |
| Appl. 4 | 2-stage cooling thermostat |
| Appl. 5 | 2-stage heating and cooling thermostat |
| Appl. 6 | 1-stage cooling thermostat with low temperature alarm |
| Appl. 7 | 1-stage heating thermostat with overheating alarm |
| Appl. 8 | 2-stage overheating alarm |
| Appl. 9 | High and low temperature alarm |
| Appl. 10 | Gutter thermostat, relay 2 = fault alarm |
| Appl. 11 | Gutter thermostat with whole numbers, relay 2 = fault alarm |

4. INSTALLATION

CMT is mounted on a DIN rail and is adapted to Norm enclosures.

Gutter thermostat (application 10 and 11)

Positioning of thermostat and outdoor temperature sensor.

In order to counteract icing heated cables are used in guttering and downpipes. The temperature at which ice forms varies from building to building depending on several factors such as, on the degree of insulation, the compass direction, radiated heat from the Sun, etc. Position the thermostat in an easily acces-

sible position for service personnel inside the building. The outside temperature sensor is positioned on the building's north elevation in a position away from direct sunlight, e.g. under the soffit See figure 3.

5. MAINTENANCE

CMT is maintenance-free.

6. BUTTONS AND MENU SYSTEM

▲ = Step up in the menu / increase value - Keep the button depressed and the reference value counts up rapidly.

▼ = Step down in the menu / decrease value - Keep the button depressed and the reference value counts down rapidly.

↻ = Is a multi-function button whose current function* is shown in the display beside the button.

* Central button functions:

- Exit Menu = Exit the menu/Save setting
- Menu Enter = Enter submenu
- Menu = Enter the menu or select application
- Enter = Confirm setting
- Reset = To reset relay after alarm, applications 6-9

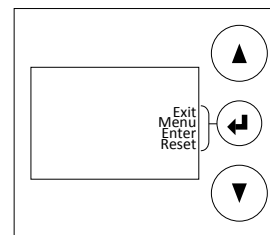

The menu system consists of the following sub-menus:

1. Selection of temperature sensor
2. Setting of hysteresis
3. Fine-adjustment of the temperature measurement
4. Timer functions
5. End the menu system

7. SELECTION OF APPLICATION/ FUNCTION

CMT is a multi-functional thermostat with eleven selectable applications:

To select an application the central button must be in function: "Menu". Press ↻ and keep it depressed. Then press ▲ and keep both buttons depressed for 4 seconds. APP will now be displayed in the upper left-hand corner with the relevant application number. On the one side of the thermostat there is an application overview. Mark the sticker with the application setting for future service and maintenance. Choose the desired application with ▲ and ▼ then confirm with Enter (↻).

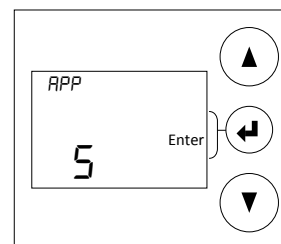

Selectable applications

Appl.	Function	Factory settings				
		Reference value °C stage 1	Reference value °C stage 2	Hysteresis °C stage 1	Hysteresis °C stage 2	Time setting in minutes (adjustable)
1	1-stage heating thermostat	23	-	0,6	-	
2	1-stage cooling thermostat	25	-	1	-	
3	2-stage heating thermostat	23	21	0,6	0,6	
4	2-stage cooling thermostat	25	27	1	1	
5	2-stage heating and cooling thermostat	22	24	0,6	1	
6	1-stage cooling thermostat with low temperature alarm *1	5	1	1	0	0 (0-120) *3
7	1-stage heating thermostat with overheating alarm *1	50	85	0,6	0	0 (0-120) *3
8	2-stage overheating alarm *1	40	60	0	0	0 (0-120) *3
9	High and low temperature alarm *1	8	3	0	0	0 (0-120) *3
10	Gutter thermostat *2, relay 2 = fault alarm	-5	5	0,6	0,6	0 (0-120) *4
11	Gutter thermostat *2 with whole numbers, relay 2 = fault alarm	-5	5	0,6	0,6	0 (0-120) *4

*1) The alarm relay is activated in normal operational mode and is deactivated in the event of an alarm or power loss. In the event of an alarm "ALARM" is displayed under the respective alarm reference value.

*2) Double thermostat where relay 1 activate heating when the outside temperature is between set point 1 and 2 (the temperature at which snow on a roof can melt and form icicles).

*3) Delayed alarm time, e.g. to allow for defrosting.

*4) After-running time: To ensure de-icing.

In the event of alarm (applications 6-9) the relay(s) are locked in the alarm condition until the Reset button has been depressed. If the alarm condition reverted to "normal temperature" when the Reset button was depressed, the relay is reset and the central button reverts to the Menu function.

If the alarm condition persists, when pressing the Reset button, the relay will not be reset. However, the central button reverts to Menu function for 5 seconds in order to allow settings in the menu system, or in order to change application.

The set point values and alarm reference values can always be adjusted even during an alarm condition. See section 9.

CMT has a monitor for the temperature sensor and disconnects from heating or cooling in the event of short-circuit or interruption in the sensor circuit. However this is not valid for the gutter thermostat function in application 10.

8. SELECTION OF TEMPERATURE SENSOR

CMT can be connected to several different types of temperature sensor: Pt100, Pt1000, Ni1000 and the ETF series for Calectro's NTC and PTC sensors. Pt1000 is the factory set sensor type.

- Press the Menu button (⬅) to access the menu system
- The actual type of temperature sensor will be displayed.
- Press Menu-Enter to change the type of temperature sensor
- The actual sensor type now starts to flash and it is now possible to select another sensor type using the arrow buttons. Confirm

your selection with Enter.

- Use the arrow buttons to step, and confirm Exit-Menu to terminate and save setting.

9. SETTING OF PREFERRED VALUES/SET POINT

To change set points press ▲ or ▼ to achieve the desired value. The set point value will flash during setting. Confirm and terminate with Enter (⬅). In cases where the selected application contains two set point values the next value will now start to flash. Change with ▲ or ▼ to the desired value and confirm with Enter (⬅). Done!

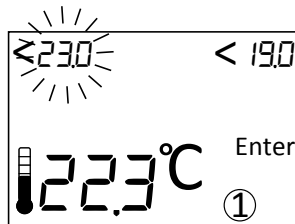

Set point values and relays:

1-stage applications:

- The reference value to the left controls the function for relay 1.

2-stage applications:

- The reference value to the left controls the function for relay 1.
- The reference value to the right controls the function for relay 2.

Example:

Set point value for relay 1 is displayed in the upper left-hand corner: The 'less-than' symbol (<) indicates that the relay is calling for heat when the temperature is lower than the set point value = heating function.

Set point value for relay 2 is displayed in the upper right-hand corner: The 'greater than' symbol (>) indicates that the relay is calling for cooling when the temperature is higher than the set point value = cooling function.

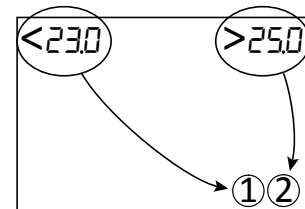

10. SETTING OF HYSTERESIS

CMT has an adjustable hysteresis (switching differential) which is centred over the set point value. The factory setting for the heating thermostat is 0.6°C and for the cooling thermostat 1.0°C.

Example: A heating thermostat with set point value of 22°C and hysteresis 0.6°C. The relay activates the heater at lower than 21.7°C and reverts at greater than 22.3°C.

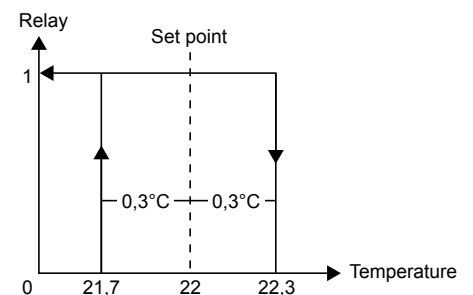

No hysteresis is used for alarm functions.

- Press the Menu button (⬅) to access the menu system
- Step using the arrow buttons until "Hyst" is shown on the display.
- Press Menu-Enter to change hysteresis.
- The actual hysteresis now starts to flash and it is now possible to adjust the hysteresis using the arrow buttons. Confirm your selection with Enter (⬅).
- Use the arrow buttons to step, and confirm Exit-Menu to terminate and save setting.

11. FINE ADJUSTMENT OF THE TEMPERATURE MEASUREMENT

If necessary the temperature measurement in the CMT can be adjusted. Range: -3.0°C to +3.0°C in steps of 0.1°C.

1. Press the Menu button (⏏) to access the menu system.
2. Step using the arrow buttons until "Adj" is shown on the display.
3. Press Menu-Enter to adjust.
4. The actual compensation and temperature now starts to flash and it is now possible to adjust the compensation using the arrow buttons. Confirm your selection with Enter (⏏).
5. Use the arrow buttons to step and confirm Exit-Menu to terminate and save setting.

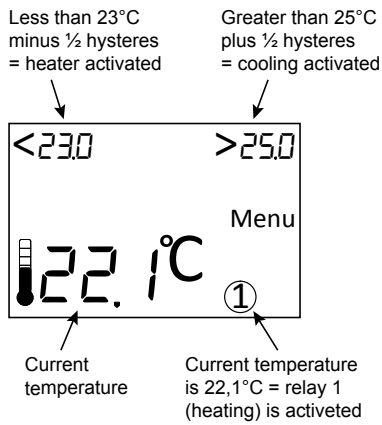

Display example application 8

The example below shows a 2-stage overheating temperature alarm with alarm set point values of 40.0°C and 60.0°C. The temperature is now 49.1°C and relay 1 is activated.

The "greater than" symbol ">" to the left of set point values 1 and 2 indicates function for overheating alarm: The relays go into alarm condition when the temperature is more than the respective alarm set point value (hysteresis is not used in alarm functions).

The text Alarm shows which set point that is exceeded.

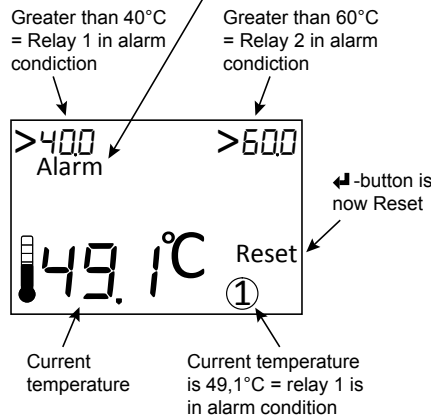

13. DISPLAY EXAMPLE

Relay symbols in the display

The ① symbol is shown in the display when relay 1 is calling for heating, cooling or is in an alarm condition (depending on application selected). The same is valid for the symbol for relay 2.

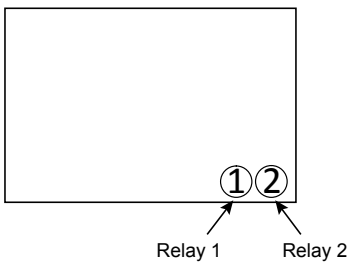

Display example application 5

The example below shows a 2-stage heating/cooling thermostat with set point values of 23.0°C and 25.0°C. The temperature is now 22.1°C and relay 1 is activated.

The "less than" symbol "<" to the left of set point value 1 indicates heating function: Relay 1 is activated when the temperature is less than the set point value (minus half the hysteresis).

The "greater than" symbol ">" to the left of set point value 2 indicates cooling function: Relay 2 is activated when the temperature is greater than the set point value (plus half the hysteresis).

14. ERROR CODES

CMT has a monitor for the temperature sensor and disconnects from heating or cooling in the event of short-circuit or interruption in the sensor circuit. In the case of interruption the display shows Er0 and in the case of short-circuit Er1 is displayed.

- Er0 Interruption in the sensor intake
- Er1 Short-circuit in the sensor intake
- Er2 Temperature out of range

Temperature/ohm table

Sensor type	Temperature	Ohm
Pt1000	0°C	1000
	20°C	1078
	40°C	1156
Pt 100	0°C	100
	20°C	107,8
	40°C	115,6
Ni1000	0°C	1000
	20°C	1090,7
	40°C	1185,7

NTC (Calectro type 22/33/44/55/99)	0°C	37942
	20°C	14871
	40°C	6539
PTC Calectro type 95)	0°C	1631
	20°C	1915
	40°C	2226

15. RESETTING FACTORY SETTINGS

In changes to or reselection of application settings will revert to factory settings. The type of temperature sensor and its possible fine-adjustment will, however, not be affected. See section 7: Select Application/Function.

16. FIGURES

FIG. 1

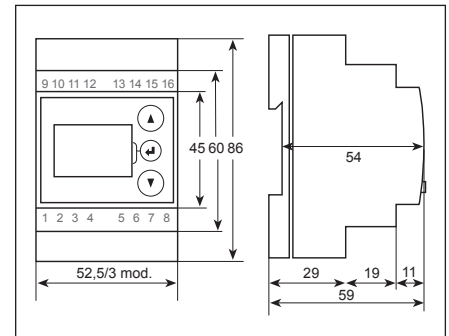

FIG. 2

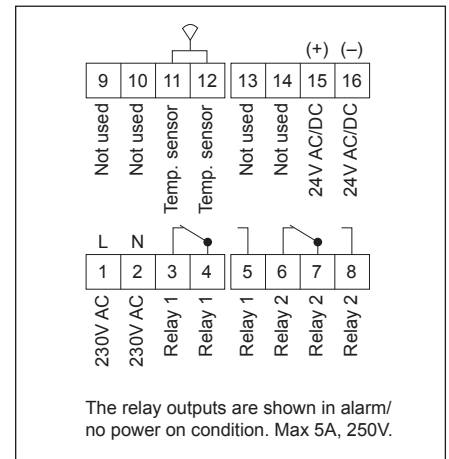
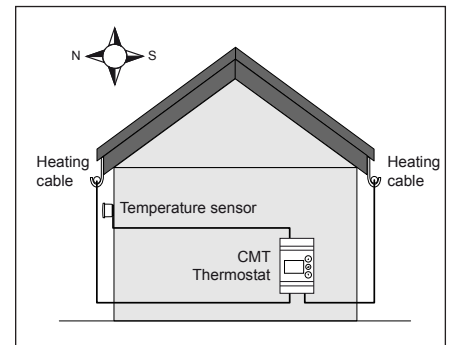
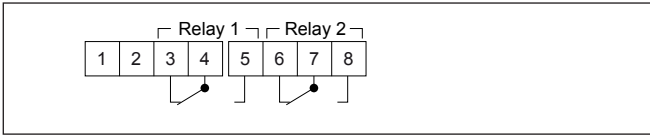

FIG. 3



17. CONNECTION EXAMPLES FOR EACH RESPECTIVE APPLICATION

Relays are shown in a currentless condition



Application 1: 1-stage heating

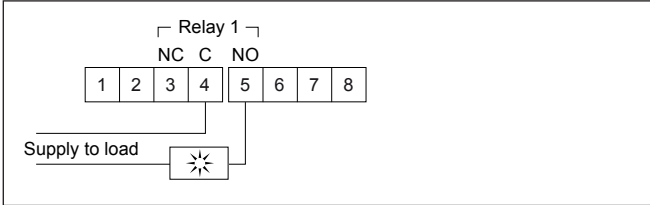

Application 2: 1-stage cooling

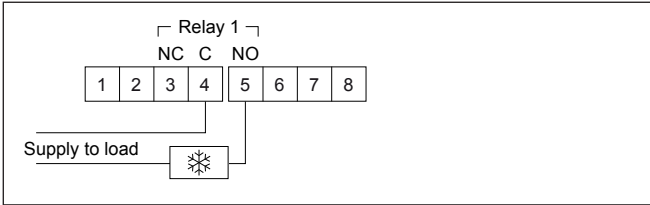

Application 3: 2-stage heating

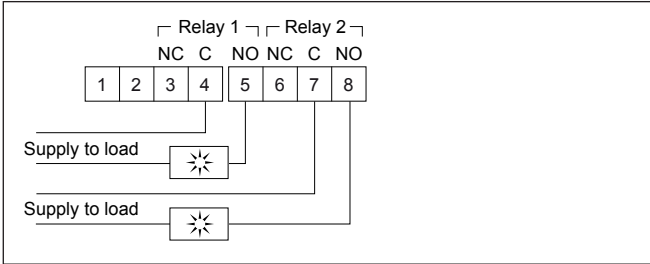

Application 4: 2-stage cooling

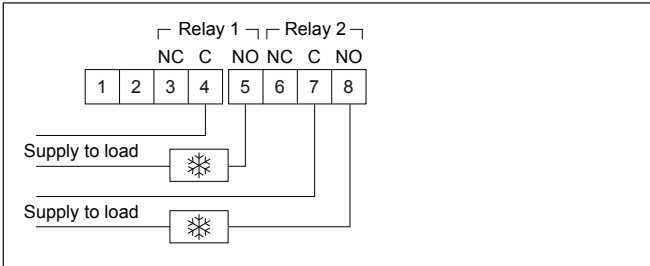

Application 5: 1-stage heating and 1-stage cooling

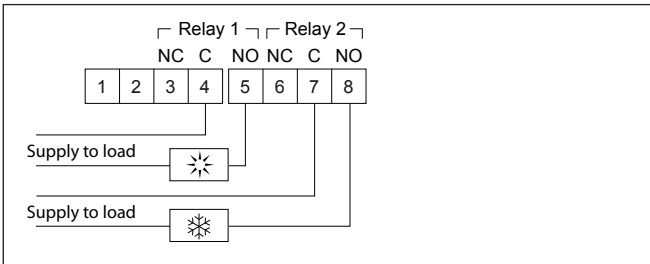

Application 6: 1-stage cooling with interlocked alarm relay

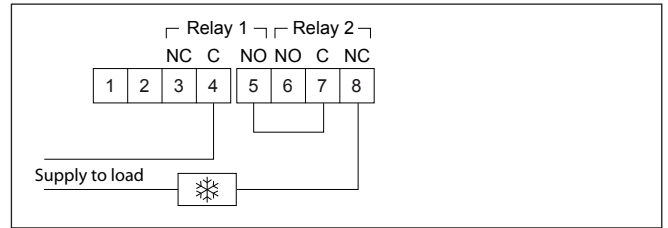

Application 7: 1-stage heating with interlocked alarm relay

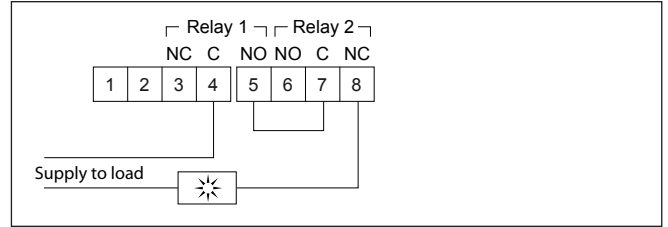

Application 8: 2-stage overheating alarm

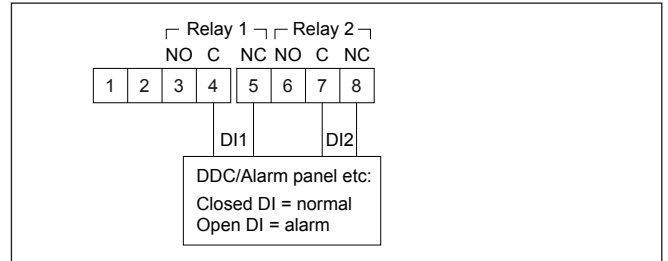

Application 9: High and low temperature alarm

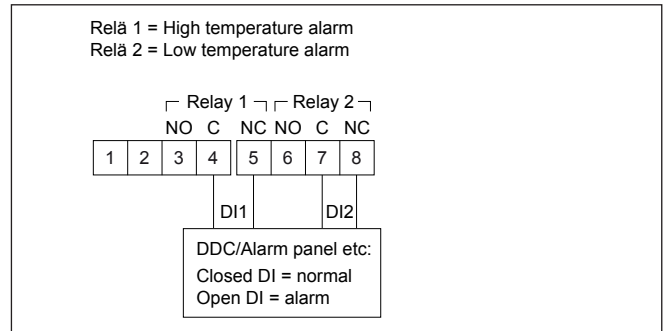

Application 10: Gutter thermostat, relay 2 = fault alarm

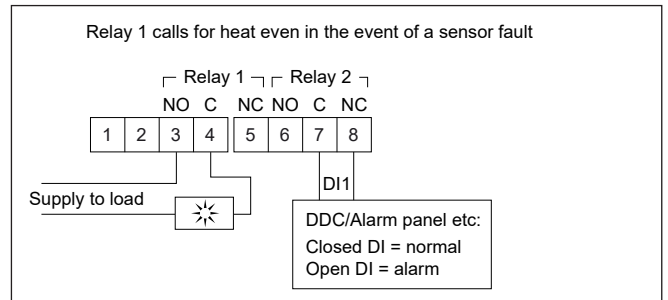

Application 11: Gutter thermostat with whole numbers, relay 2 = fault alarm

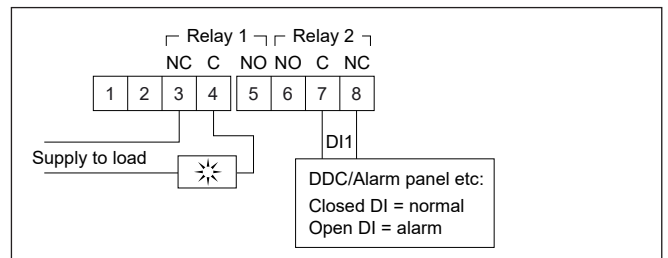

18. MENU SYSTEM - OVERVIEW

Press Menu  to access the Menu System.
 Navigate between the submenus using the arrow keys and select sub-menu with Menu-Enter.

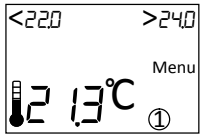

Select the type of temperature sensor. Navigate between the different types and confirm with Enter.

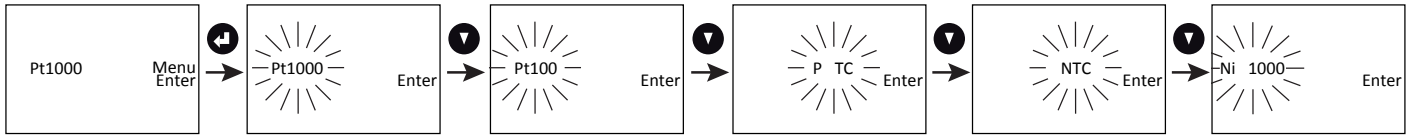

Enter the required hysteresis and confirm with Enter.

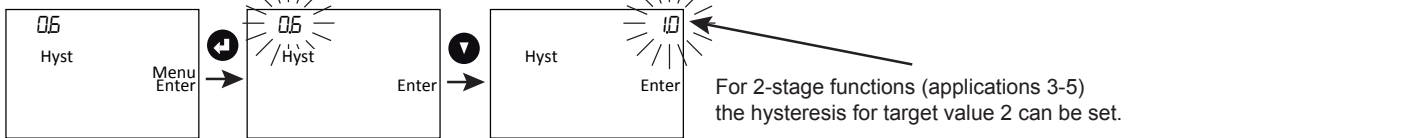

If necessary the temperature measurement may be fine-tuned (-3.0 to +3.0°C). Confirm with Enter.

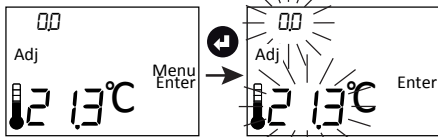

Select the required alarm delay or after-run time. Confirm with Enter.

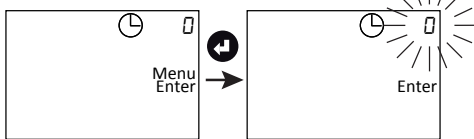

Save settings and return to the normal display position through Exit-Menu.

